

## OPENWELL SUBMERSIBLE PUMPS - 50Hz





**C.R.I. PUMPS**  
Pumping trust. Worldwide.

## Vision, Mission and Values

To be the industry leader providing best - in - class fluid management solutions to individual and institutional customers and societies in our chosen markets.

We will achieve this through our dedicated efforts to enhance the welfare of all our stakeholders and by living by our values of **commitment, reliability** and **innovation**.

## T H E B E G I N N I N G

of C.R.I., way back in 1961, was a resolute attempt to produce a few irrigation equipments using the limited facilities of an in-house foundry. Eventually the founder's dream was coming true as the small production unit he started kept growing rapidly. Now, after more than five eventful decades, it is an enormous, widely reputed organization, which produces more than 1500 varieties of perfectly engineered pumps and motors and sells its products in numerous countries spread across 6 continents.

## C . R . I . I S O N E A M O N G

the few pioneers in the world to produce 100% stainless steel submersible pumps. Having achieved a record production capacity of over 1.5 million pumps per annum, today C.R.I. is rubbing its shoulders with the best brands in the world, with advanced technology and safety standards as its hallmarks.

## T H E I N F R A S T R U C T U R E

of C.R.I. is pretty comprehensive with state-of-the-art machineries and high potential in-house R&D recognised by the ministry of science and technology, Govt. of India - all within its own covered area of 200,000 square metres. The production environment is accredited with ISO 9001 & 14001 certifications and the products are CE, UR/UL, TSE & ISI certified. The R&D team always stays in tune with the changing scenario and seldom fails in coming up with outstanding solutions every time.

## N E E D L E S S T O S A Y ,

behind this legendary growth lies the untiring, innovative, enthusiastic and dedicated team work. and, of course, a flawlessly maintained value system too. The name C.R.I. itself encapsulates the company's ethos: “ **Commitment, Reliability, Innovation**”.



# OPENWELL SUBMERSIBLE PUMPS

## LB, LH & LT - Series



## DESCRIPTION

C.R.I. Horizontal & Vertical Openwell Submersible pumps are the products of expertise gained from over five decades of experience, endurance and workmanship. These products are engineered to perfection with utmost care and stringent quality control at all stages to ensure a trouble free service.

C.R.I. Horizontal & Vertical Openwell Submersible pumps are ideally suitable for wide range of applications. Suction and priming problems do not arise as these pumps are submersible type. Pump volute chamber is designed to give the best possible hydraulic efficiency and the dynamically balanced impellers offers vibration free operation with long life. Specially designed thrust bearing withstands high thrust load and ensures durability.

### Features

No suction & priming problem | No need of pump house | Noiseless operation | High operating efficiency | Water lubricated bushes | Highly durable water cooled rewindable motor | Can be easily dismantled & repaired.

### Applications

Residential | Irrigation | Drip & Sprinkler system | Public water supply | Industrial & Rural water supply.

### Performance Curve Conditions

The conditions below apply to the curves shown on the following pages

Curve tolerance according to ISO 9906. Grade 3B | The performance are at rated voltage and are only indicative. Actual discharge depends on availability of water in well / tank, height of water column from the suction pipe end | The measurements were made with airless water at 20°C. When pumping liquids with a density higher than of water, motors with correspondingly higher outputs must be used | The bold curves shaded values indicate the recommended performance range | Pipe friction losses have not been included in the performance curves & performance tables | The pipe connection threads are given as per BSP standard | The main scales of the Performance curve are metre and lps which have been given for head and flow respectively | The performance curves show pump performance at rated speed 2900 rpm, rated voltage and @ 0.5m. minimum submergence.

### Important Notes:

Read our operator's manual carefully before installation | Pump should not be operated dry. Install dry run preventor to protect the pumpset from dry running | Use appropriate size, good quality cable and starter / protection devices | Use low friction good quality pipes | The pipe diameters must never be smaller than the pump connections | Install pump according to our recommended Head range | Reduce number of bends, elbows, T-bends as much as possible in the pipe line | Pump should be run for few minutes atleast once in 2 days to prevent from seizing | It is mandatory to install a control box for all pumpsets | Avoid fatal electrical shock or injury by disconnecting power before working on or around the pumping system | Only technically qualified personnel must perform the works complying with local electricity rules and regulations. To reduce the risk of electrical shock during operation, an appropriate earthing is mandatory | Maximum permissible supply voltage should lie between  $\pm 10\%$  of the rated voltage | The performance data and curves are at rated voltage and only indicative | Pipe sizes mentioned in inches are nominal pipe sizes and are nearest conversion of mm.

# OPENWELL SUBMERSIBLE PUMPS

LB, LH & LT - Series

## Model Identification Code

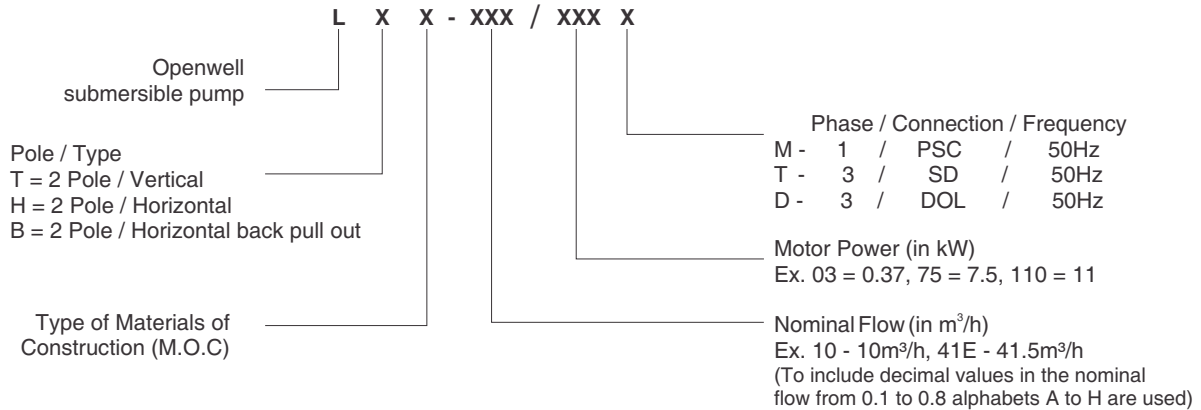

## Technical Specifications

Specifications	Vertical - LT Series	Horizontal - LH Series	Horizontal - LB Series
Power Range	3.0 kW to 45 kW - 3Ph 1.1 kW to 2.2 kW - 1Ph	3 kW to 18.5 kW	0.75 kW to 2.2 kW
Speed	2900 rpm	2900 rpm	2900 rpm
Version	3Ph-380-415V, 1Ph-230V 50Hz A.C. Supply	Three Phase 380-415V 50Hz A.C. Supply	Single phase 230V, 50Hz, A.C. Supply
Max. Discharge	215 m <sup>3</sup> /h	187 m <sup>3</sup> /h	10 m <sup>3</sup> /h
Max. Head	320 m	80 m	33 m
Degree of Protection	IP 58	IP 58	IP 58
Direction of Rotation	CCW, CW - Three Phase	CCW, CW - Three Phase	CCW - Single Phase
Type of Duty	S1 (Continuous)	S1 (Continuous)	S1 (Continuous)
Max. Starts per Hour	6 Times	6 Times	6 Times
Method of Starting	3Ph - DOL / SD, 1Ph - PSC	Direct Online / Star Delta	Permanent Split Capacitor
Lead out cable	Permanently connected and sealed PVC insulated 3 core flat cable	Permanently connected and sealed PVC insulated 3 core flat cable	Permanently connected and sealed PVC insulated 3 core flat cable
Nominal Outlet Sizes in Inches	1, 1½, 2, 2½, 3, 4 & 6	2, 2½, 3 & 4	1, 1½ & 2

## Pumped Liquids :

Clean, thin, non-aggressive, non-explosive, clear, cold, fresh water without abrasives solid particles or fibres having the following characteristics.

Temperature	33°C (max.)
Permissible Amount Of Sand	25 grams /m <sup>3</sup> (max.)
Chlorine Ion Density	500 ppm (max.)
Allowable Solids	3000 ppm (max.)
Specific Gravity	1.004 (max.)
Hardness (drinking Water)	300 (max.)
Viscosity	1.75 x 10 <sup>-6</sup> m <sup>2</sup> /sec (max.)
Turbidity	50 ppm silica scale (max.)
pH	6.5 to 8.5

## Materials of Construction

PART NAME	TYPE - B	TYPE - F	TYPE - G
PUMP CASING	C.I.	C.I.	S.S.
PUMP BRACKET	C.I.	C.I.	C.I.
IMPELLER	BRONZE	BRONZE	S.S.
MOTOR FRAME	S.S.	M.S.	M.S.
SHAFT	S.S.	S.S.	S.S.
THRUST BEARING	FIBRE & BRONZE	FIBRE & BRONZE	FIBRE & BRONZE

# HORIZONTAL OPENWELL SUBMERSIBLE PUMPS

LB & LH - Series

## CROSS SECTIONAL DRAWING

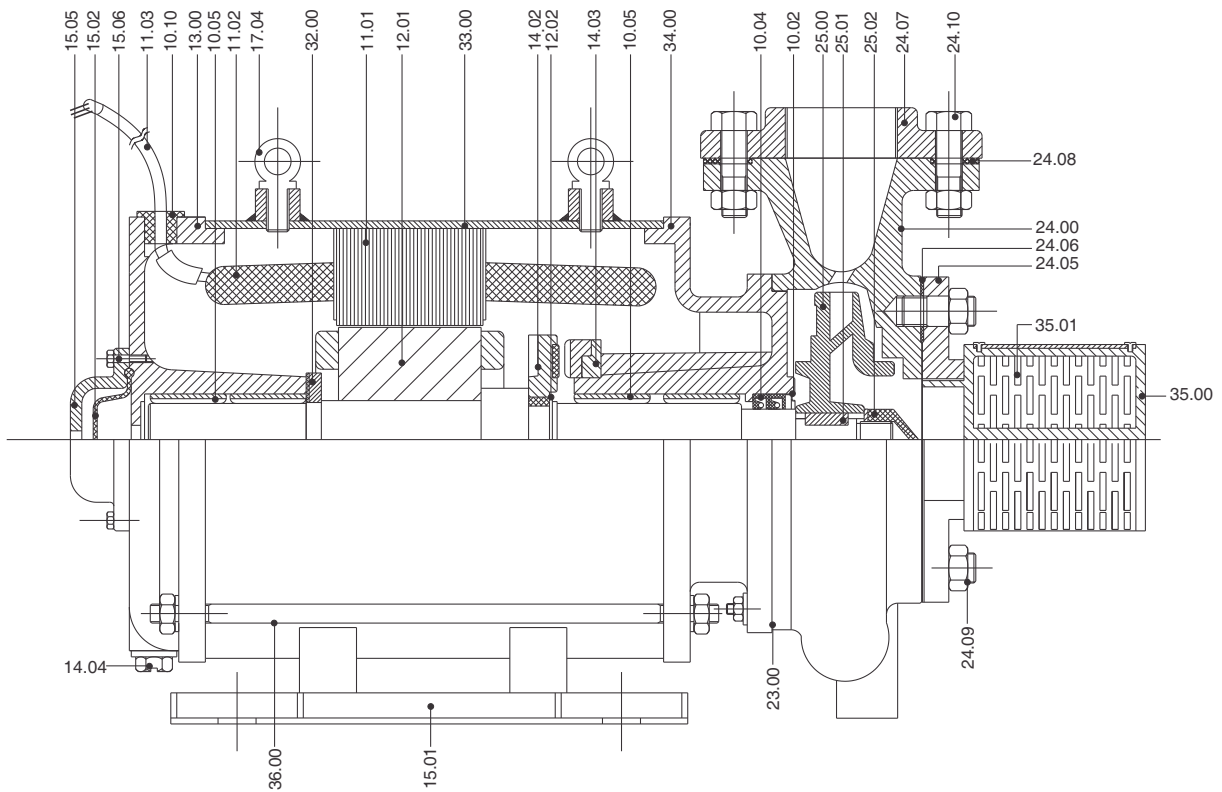

PART No	COMPONENT DESCRIPTION	PART No	COMPONENT DESCRIPTION
10.02	Oil Seal Guard	23.00	Gasket (Pump Casing)
10.04	Oil Seal	24.00	Pump Casing
10.05	Bush	24.05	Suction Flange
10.10	Cable Grommet	24.06	Suction Flange Washer
11.01	Stator	24.07	Delivery Flange
11.02	Stator Winding	24.08	Delivery Flange Washer
11.03	Cable	24.09	Suction Flange Stud and Nut
12.01	Rotor	24.10	Delivery Flange Bolt and Nut
12.02	Circlip	25.00	Closed Impeller
13.00	Back Cover	25.01	Impeller Key
14.02	Thrust Pad	25.02	Impeller Nut
14.03	Thrust Base	32.00	Counter Thrust Pad
14.04	Drain Plug	33.00	Shell
15.01	Base	34.00	Front Bracket
15.02	Breather Diaphragm	35.00	Foot Valve
15.05	Diaphragm Cap	35.01	Inlet Screen
15.06	Diaphragm Cap Bolt	36.00	Locking Stud / Strip
17.04	Eye Bolt		

# VERTICAL OPENWELL SUBMERSIBLE PUMPS

LT - Series

## CROSS SECTIONAL DRAWING

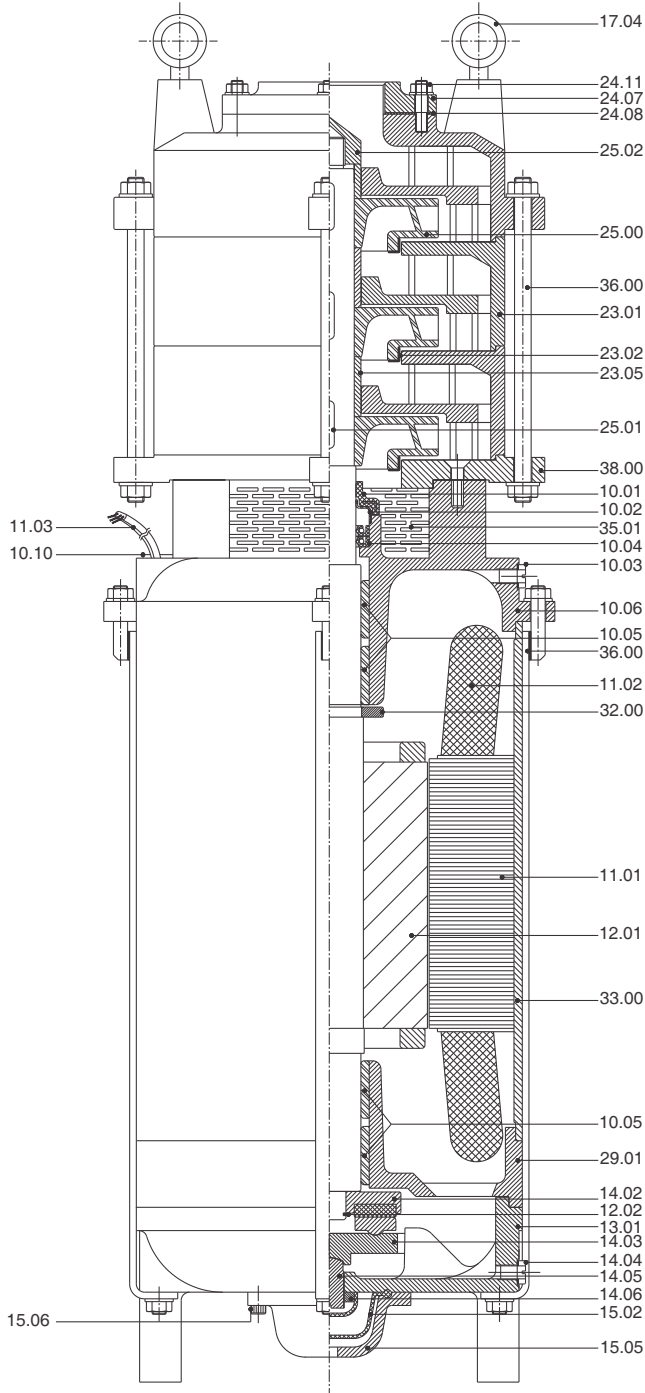

PART No.	COMPONENT DESCRIPTION
10.01	Sand Guard
10.02	Oil Seal Guard
10.03	Water Filling Plug
10.04	Oil Seal
10.05	Bush
10.06	Upper Housing
10.10	Cable Grommet
11.01	Stator
11.02	Stator Winding
11.03	Cable
12.01	Rotor
12.02	Circlip
13.01	Lower Housing
14.02	Thrust Pad
14.03	Thrust Plate
14.04	Drain Plug
14.05	Rocker Screw
14.06	Rocker Nut
15.02	Breather Diaphragm
15.05	Diaphragm Cap
15.06	Diaphragm Cap Bolt
17.04	Eye Bolt
23.01	Diffuser Chamber
23.02	Impeller Seal Ring
23.05	Sleeve
24.07	Delivery Flange
24.08	Delivery Flange Washer
24.11	Delivery Flange Stud and Nut
25.00	Closed Impeller
25.01	Impeller Key
25.02	Impeller Nut
29.01	Bush Chamber
32.00	Counter Thrust Pad
33.00	Shell
35.01	Inlet Screen
36.00	Locking Stud / Strip
38.00	Top Plate

# HORIZONTAL OPENWELL SUBMERSIBLE PUMPS

## Performance Curves & Table

## LB - Series

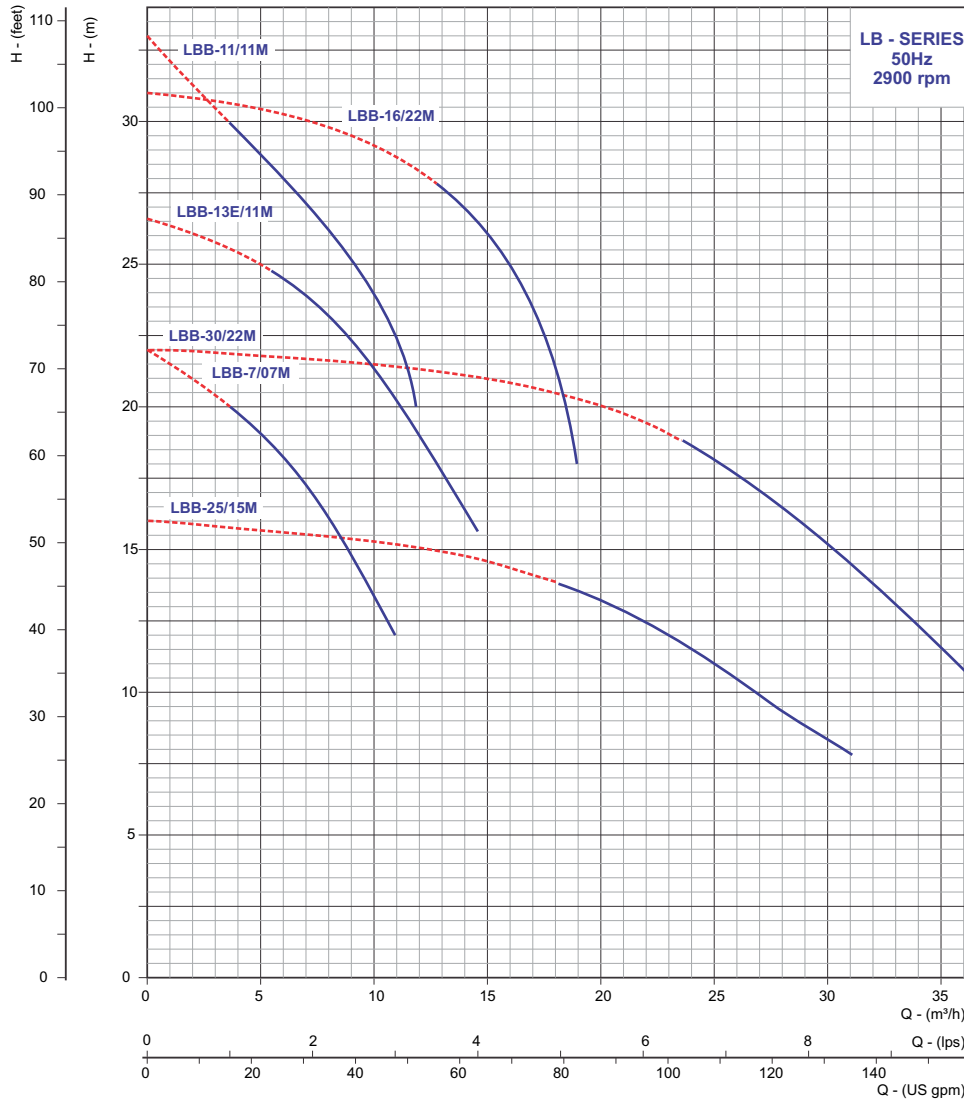

PUMP MODEL	MOTOR POWER		OUTLET SIZE IN mm	m³/h	HEAD IN METERS																		
	HP	kW			0	3.6	5.4	7.2	9	10.8	13	14	16.2	18	21.6	23.4	25.2	27	30.6	32	34.2	36	
			IN mm	lps	0	1	1.5	2	2.5	3	3.5	4	4.5	5	6	6.5	7	7.5	8.5	9	9.5	10	
LBB-25/15M	2.0	1.5	50	16											13.7	12.5	11.7	10.7	9.7	8.8			
LBB-7/07M	1.0	0.75	25	22	20	19	17	14.5															
LBB-30/22M	3.0	2.2	50	22												18.7	17.9	16.7	15.7	13.2	12.4	10.5	
LBB-13E/11M	1.5	1.1	25	26.6			23.7	22.2	20.2	18	15.6												
LBB-16/22M	3.0	2.2	40	31							28	26.5	24.3	20.8									
LBB-11/11M	1.5	1.1	25	33			26.8	24.9	22.5														

In view of continuous developments the information / description / specification / illustration are subject to change without notice.

# HORIZONTAL OPENWELL SUBMERSIBLE PUMPS

## Performance Table & Curves

## LH - Series

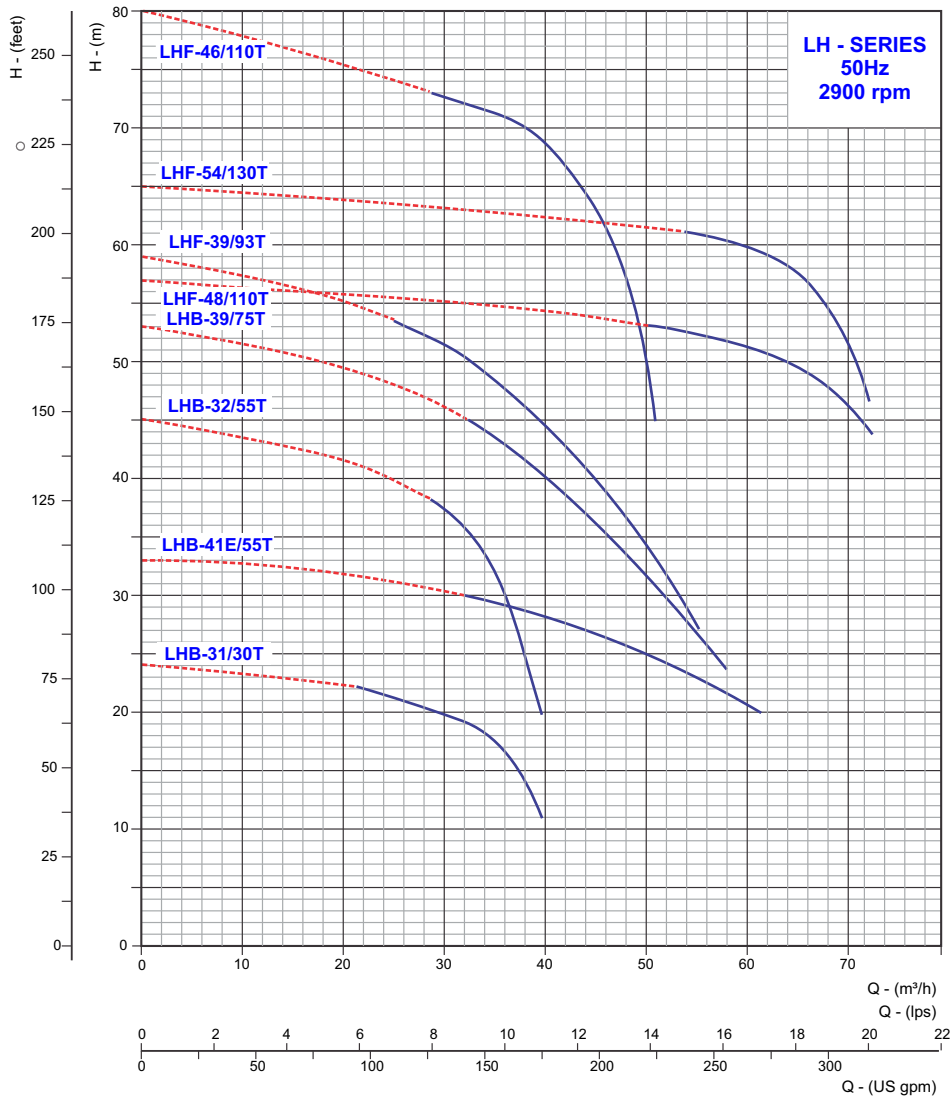

PUMP MODEL	MOTOR POWER		OUTLET SIZE IN mm	HEAD IN METERS																			
	HP	kW		m <sup>3</sup> /h	0	10.8	14.4	18	21.6	25.2	28.8	32.4	36	39.6	43.2	46.8	50.4	54	57.6	61.2	68.4	72	
			lps	0	3	4	5	6	7	8	9	10	11	12	13	14	15	16	17	19	20		
LHB-31/30T	4.0	3.0	50	24				22	21	20	19	16.5	11										
LHB-41E/55T	7.5	5.5	50	33								29	28.2	27	26	25	23.5	22	20				
LHB-32/55T	7.5	5.5	50	45							38	35.5	30	20									
LHB-39/75T	10.0	7.5	50	53							45	42.8	40	37	35	31	27	24					
LHF-48/110T	15.0	11.0	50	57					55.3	55.1	55	54.8	54.5	54	53.5	53	52.5	52	51	48	44		
LHF-39/93T	12.5	9.3	50	59					53	52	49	47	45	42	37	33	27						
LHF-54/130T	17.5	13.0	50	65													61	60	59	54	47		
LHF-46/110T	15.0	11.0	50	80						73	72	71	69	64	60	45	44						



# HORIZONTAL OPENWELL SUBMERSIBLE PUMPS

## Performance Table & Curves

## LH - Series

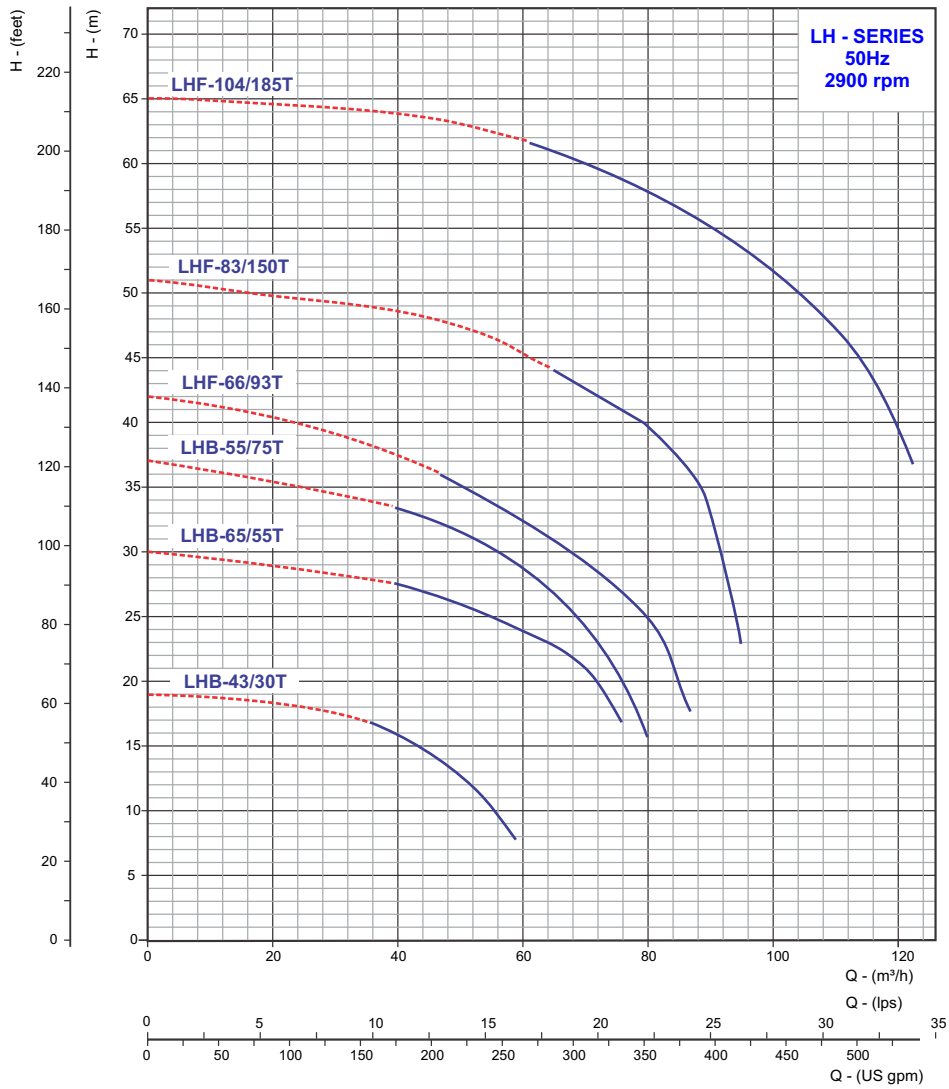

PUMP MODEL	MOTOR POWER		OUTLET SIZE IN mm	m <sup>3</sup> /h	HEAD IN METERS																							
	HP	kW			0	36	40	43	47	50	54	58	61	65	68	72	76	79	83	86	90	94	101	108	122			
			65	0	10	11	12	13	14	15	16	17	18	19	20	21	22	23	24	25	26	28	30	34				
LHB-43/30T	4.0	3.0	65	19	16.5	16	15	14	13	12	8																	
LHB-65/55T	7.5	5.5	65	30		27.5	27	26.5	25.5	25	24.5	24	22.5	21.5	20.5	17												
LHB-55/75T	10.0	7.5	65	37		33.5	33	32.5	32	30.5	29.5	28	27	25.5	23.5	20	16											
LHF-66/93T	12.5	9.3	65	42				36	35	34	33	32	31.5	31	30	28	26	24	18									
LHF-83/150T	20.0	15.0	65	51										44	43	42	41	40	38	37	34	23						
LHF-104/185T	25.0	18.5	65	65								62	61	60	59.5	58	57	56.5	56	55	54	52	49	37				

# HORIZONTAL OPENWELL SUBMERSIBLE PUMPS

## Performance Table & Curves

## LH - Series

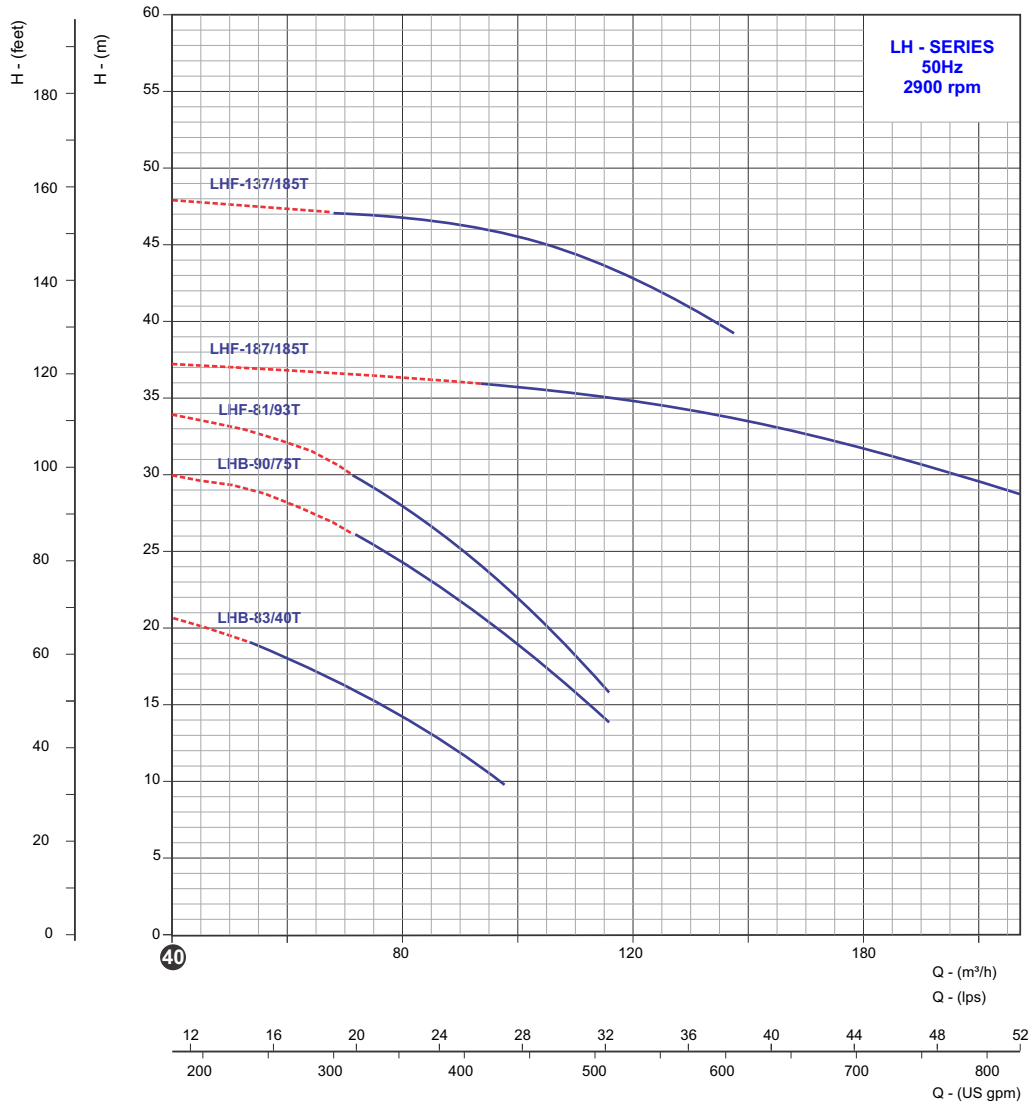

PUMP MODEL	MOTOR POWER		OUTLET SIZE IN mm	m <sup>3</sup> /h	HEAD IN METERS																		
	HP	kW			0	58	61	65	68	72	76	79	83	86	90	94	97	101	104	108	115	130	151
			lps	0	16	17	18	19	20	21	22	23	24	25	26	27	28	29	30	32	36	42	54
LHB-83/40T	5.5	4.0	80	22	18.5	18	17	16.5	16	15	14	13.5	13	12	11	10							
LHB-90/75T	10.0	7.5	80	31				26	25	24	23	22.5	22	21	20	19	18	17	14				
LHF-81/93T	12.5	9.3	80	36				30	29	28	27	26	25	24	23	22	21	20	16				
LHF-187/185T	25.0	18.5	100	38											36	35.8	35.6	35.4	35.2	35	34.4	32.4	28.4
LHF-137/185T	25.0	18.5	80	49				47.1	47	47	46.7	46.6	46.5	46	45.8	45.7	45.5	45	44.5	43	41		

# VERTICAL OPENWELL SUBMERSIBLE PUMPS

## Performance Table & Curves

## LT - Series

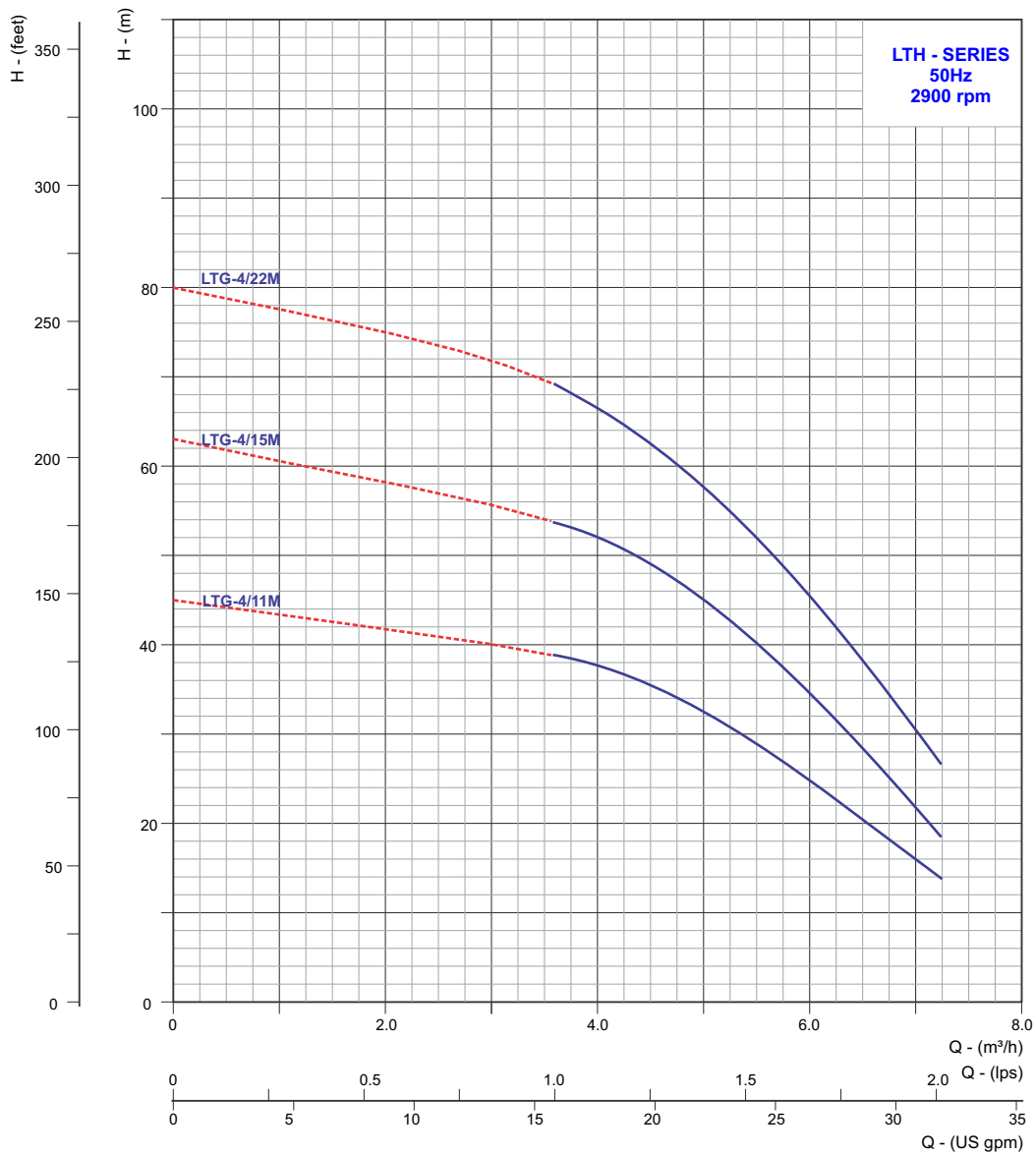

PUMP MODEL	MOTOR POWER		STAGE	OUTLET SIZE IN mm	HEAD IN METERS	0	0.9	1.8	2.7	3.6	4.5	5.4	6.3	7.2
	HP	kW				0	0.25	0.50	0.75	1.0	1.25	1.5	1.75	1.75
LTG-4/11M	1.5	1.1	5	25/32		45	43.5	42	40.5	39	35.5	30	22	14.50
LTG-4/15M	2.0	1.5	7	32/40		63	61	59	56.5	54	49.50	41	31	19
LTG-4/22M	3.0	2.2	9	32/40		80	78	75.5	73	69	63	53	41	27

# VERTICAL OPENWELL SUBMERSIBLE PUMPS

## Performance Table & Curves

## LT - Series

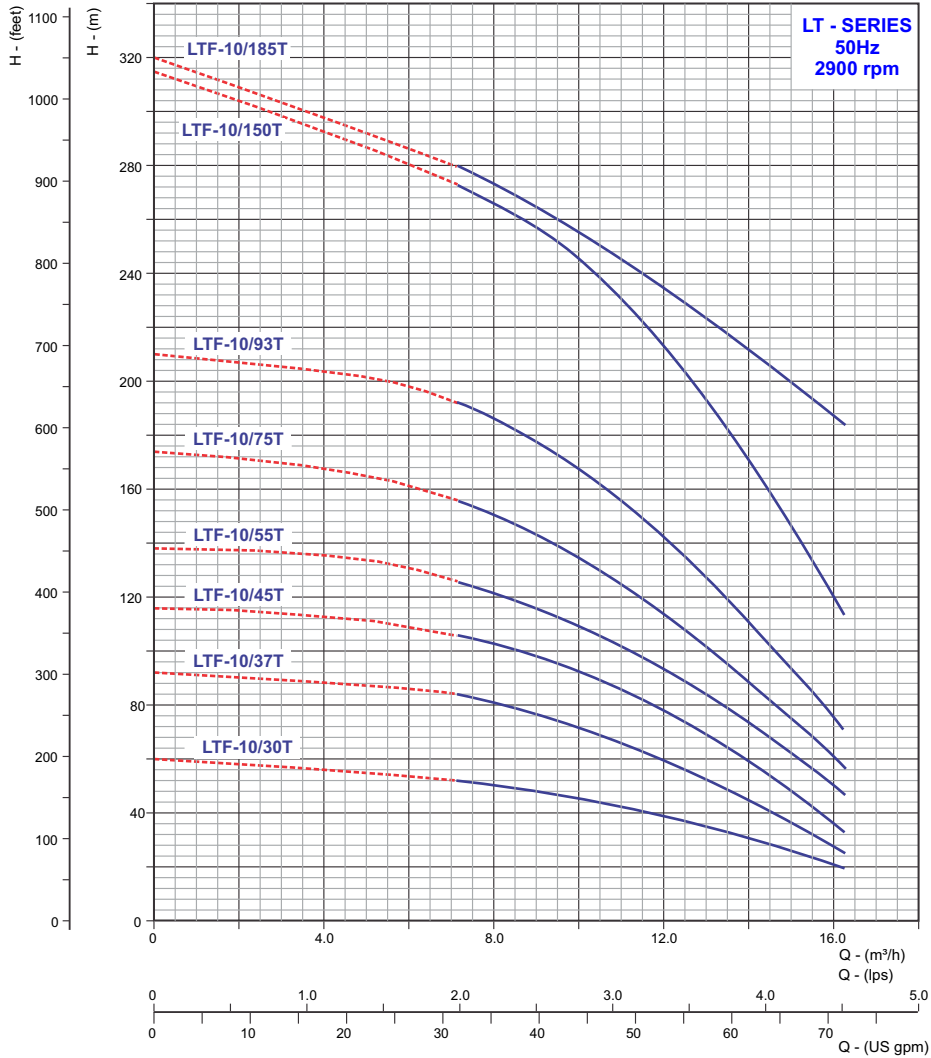

PUMP MODEL	MOTOR POWER		STAGE	OUTLET SIZE IN mm	m³/h	HEAD IN METERS															
	HP	kW				lps	0	1.8	3.6	5.4	7.2	9	10.8	12.6	14.4	16.2	18	19.8	21.6		
LTF-10/30T	4.0	3.0	3	50		0	0.5	1	1.5	2	2.5	3	3.5	4	4.5	5	5.5	6			
LTF-10/37T	5.0	3.7	5	50	60					52	48	43	36	30	20						
LTF-10/45T	6.0	4.5	6	50	92					84	76	68	56	42	32 (4.3)						
LTF-10/55T	7.5	5.5	7	50	116					105	98	88	72	55	38 (4.4)						
LTF-10/75T	10.0	7.5	9	50	138					126	116	104	89	68	48						
LTF-10/93T	12.5	9.3	11	50	174					156	144	128	108	84	59						
LTF-10/150T	20.0	15.0	16	50	210					192	178	160	136	104	72						
LTF-10/185T	25.0	18.5	16	50	315					272	256	232	200	160	116						
					320					280	265	247	228	208	186						

# VERTICAL OPENWELL SUBMERSIBLE PUMPS

## Performance Table & Curves

## LT - Series

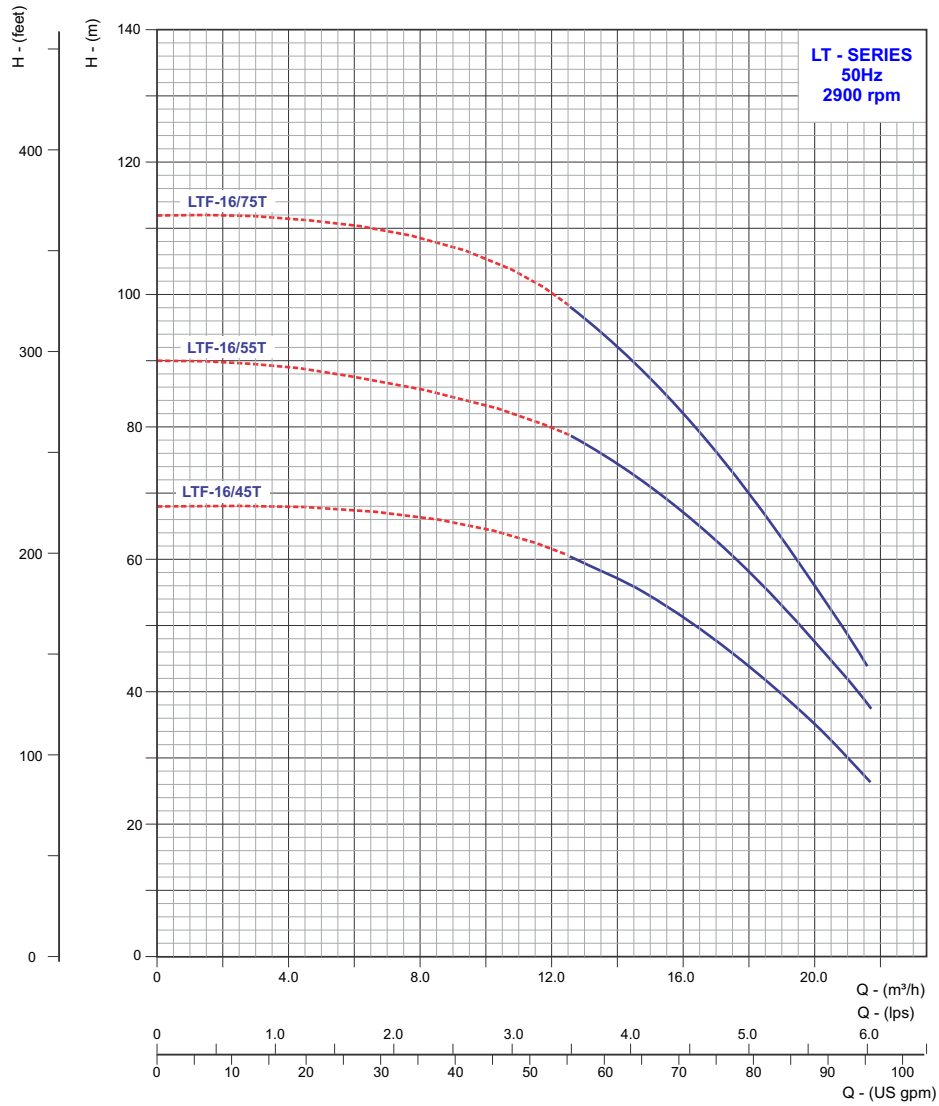

PUMP MODEL	MOTOR POWER		STAGE	OUTLET SIZE IN mm	HEAD IN METERS									
	HP	kW			0	7.2	9	10.8	12.6	14.4	16.2	18	19.8	21.6
LTF-16/45T	6.0	4.5	4	50	68				61	56	50	43	36	27
LTF-16/55T	7.5	5.5	5	50	90				79	73	66	59	49	38
LTF-16/75T	10.0	7.5	6	50	112				98	90	81	70	58	44

# VERTICAL OPENWELL SUBMERSIBLE PUMPS

## Performance Table & Curves

## LT - Series

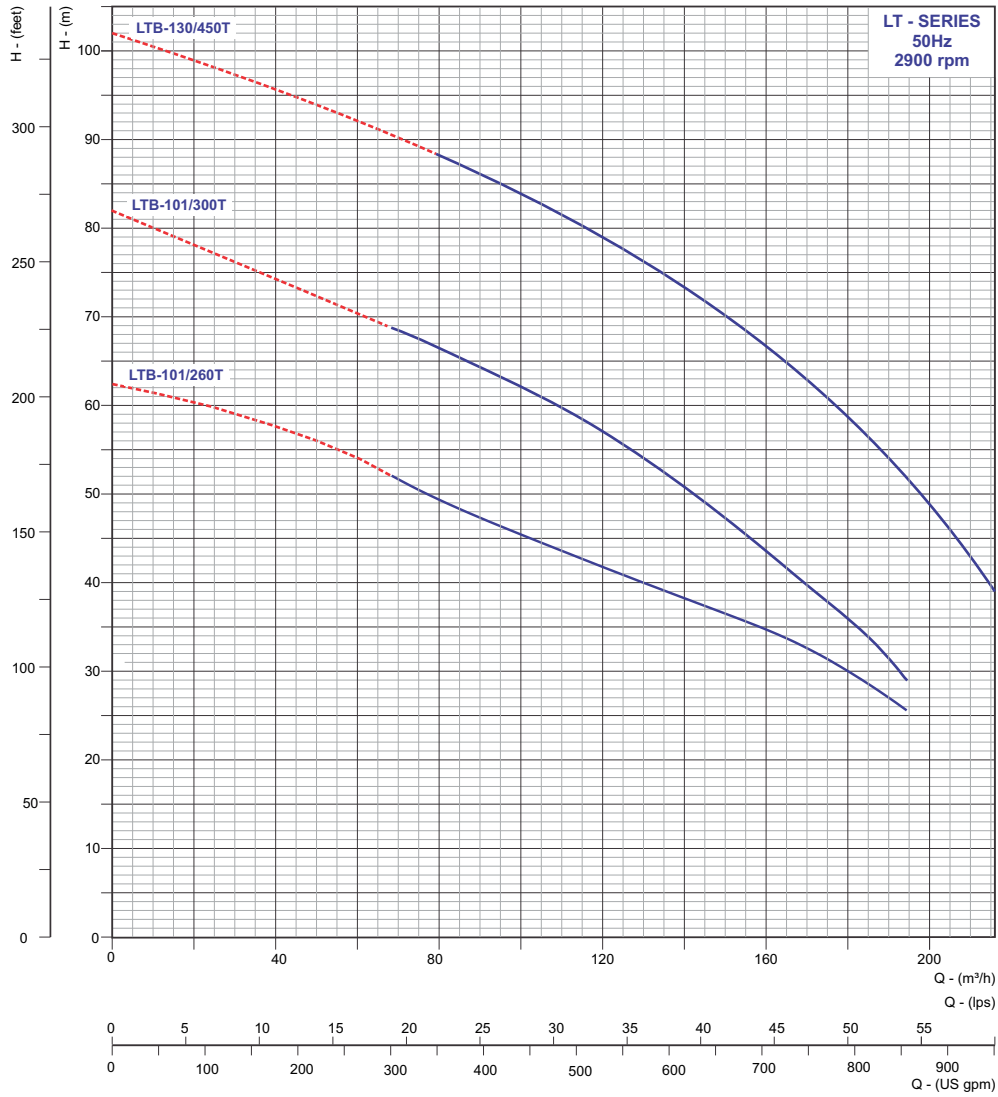

PUMP MODEL	MOTOR POWER		STAGE	OUTLET SIZE IN mm	m³/h	HEAD IN METERS																		
	HP	kW				0	75.6	100.8	108	115.2	122.4	129.6	136.8	144	151.2	158.4	165.6	172.8	180	187.2	194.4			
LTB-101/260T	35	26	2	100	lps	0	21	28	30	32	34	36	38	40	42	44	46	48	50	52	54			
LTB-101/300T	40	30	3	100	HEAD IN METERS	62.5	50	45	44	42.5	41.5	40	39	37.5	36	35	33.5	32	30	28	25.5			
LTB-130/450T	60	45	3	150	HEAD IN METERS	102		84	82	80	78	76	74	72	70	67	65	62	59	56	52			

# VERTICAL OPENWELL SUBMERSIBLE PUMPS

## Performance Table & Curves

## LT - Series

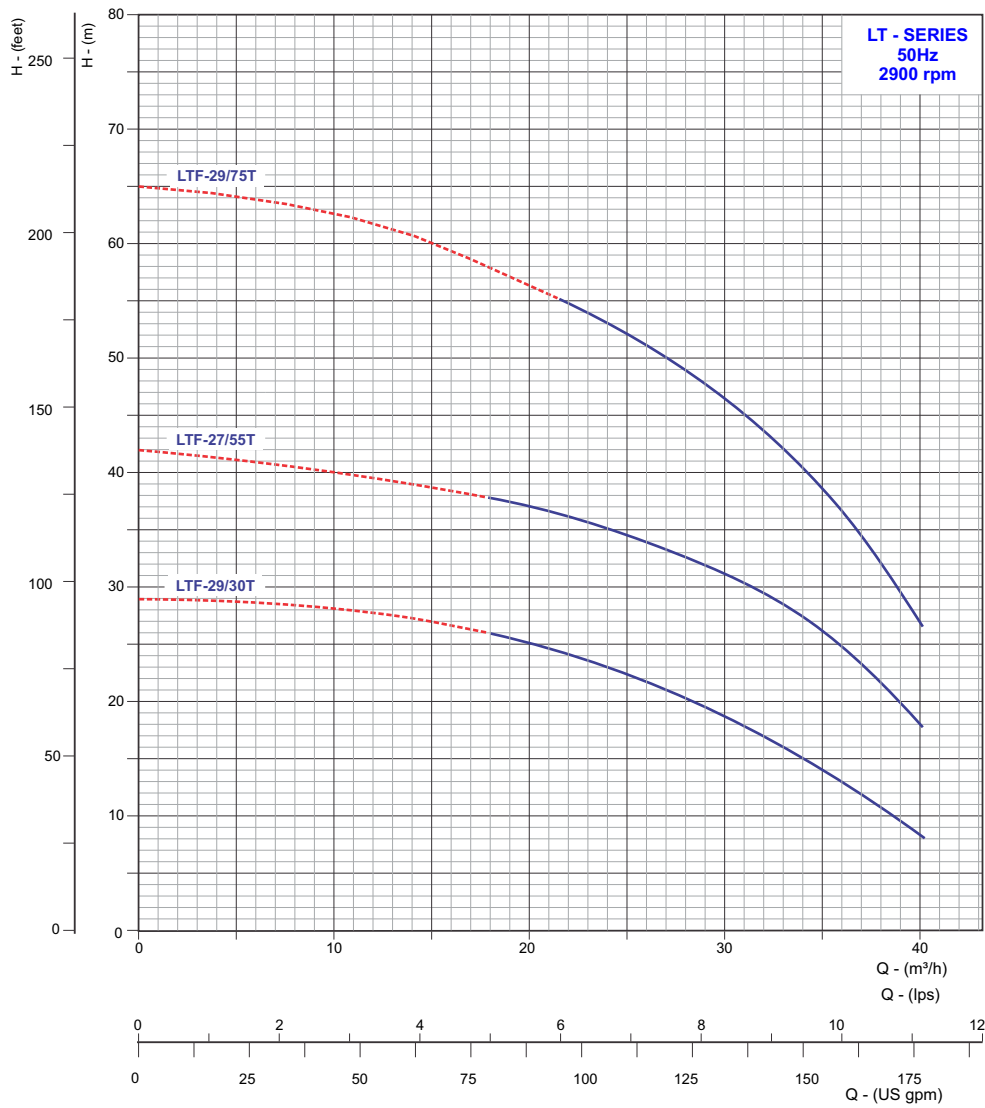

PUMP MODEL	MOTOR POWER		STAGE	OUTLET SIZE IN mm	HEAD IN METERS														
	HP	kW			0	14.4	18	21.6	25.2	28.8	32.4	36	39.6	43.2	46.8	50.4	54		
LTF-29/30T	4.0	3.0	2	65	0	4	5	6	7	8	9	10	11	12	13	14	15		
LTF-27/55T	7.5	5.5	2	65	29		26	24	22	20	17	13	8.5						
LTF-29/75T	10.0	7.5	3	65	42		38	36.5	34.5	32	29	25	19						
					65			55	52	48	43	37	28						

# VERTICAL OPENWELL SUBMERSIBLE PUMPS

## Performance Table & Curves

## LT - Series

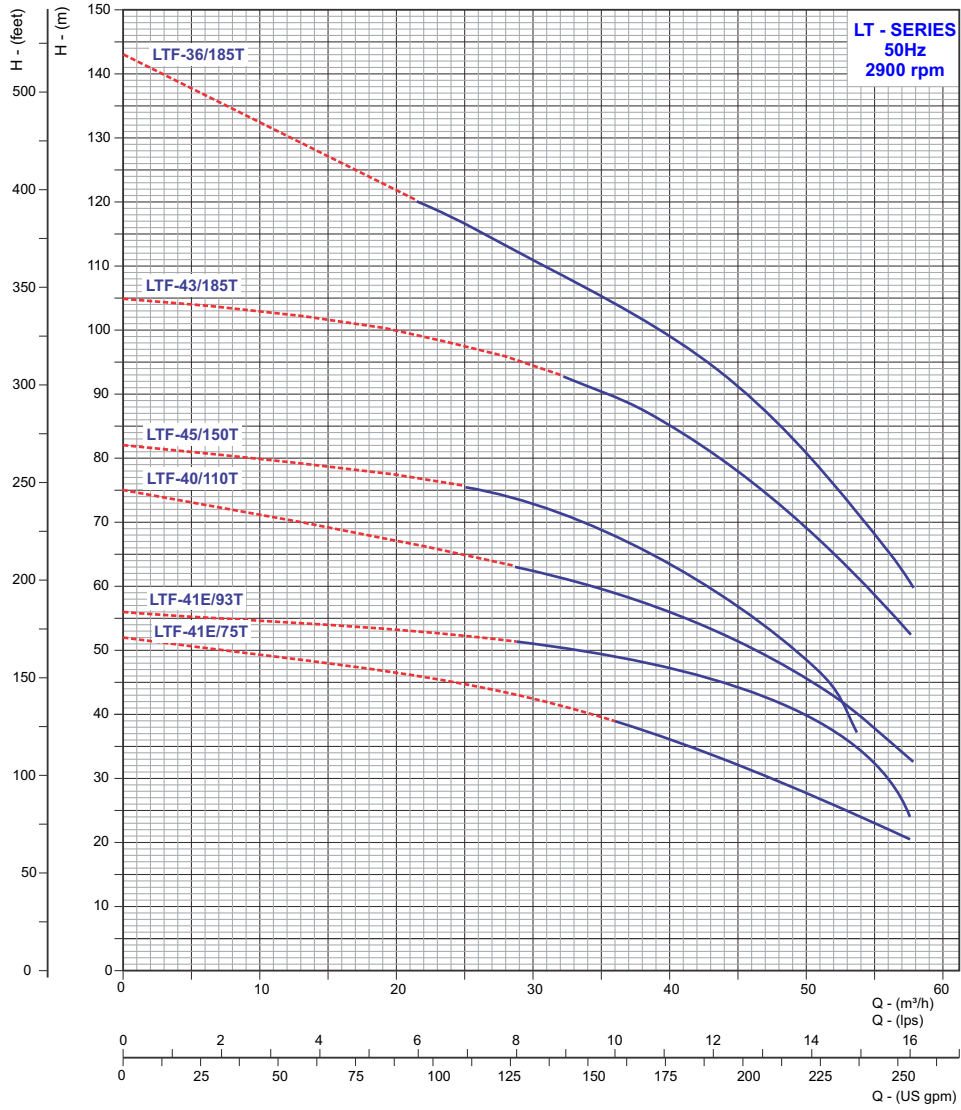

PUMP MODEL	MOTOR POWER		STAGE	OUTLET SIZE IN mm	HEAD IN METERS																
	HP	kW			0	14.4	18	21.6	25.2	28.8	32.4	36	39.6	43.2	46.8	50.4	54	57.6			
LTF-41E/75T	10	7.5	2	65/80	0	4	5	6	7	8	9	10	11	12	13	14	15	16			
LTF-41E/93T	12.5	9.3	2	65/80	52				43	41	39	36	33	30	27	24	20.5				
LTF-40/110T	15	11.0	3	65/80	56					49	47	45	42.5	39.5	35	24					
LTF-45/150T	20	15.0	3	65/80	75				63	61	59	56	53	49	45	40	33				
LTF-43/185T	25	18.5	4	65/80	82			76	74	71	68	64	58	54	48	36					
LTF-36/185T	25	18.5	6	65/80	105					93	90	85	80	75	69	60	59				
					143			120	116	112	108	104	105	99	88	80	70	60			



# VERTICAL OPENWELL SUBMERSIBLE PUMPS

## Performance Table & Curves

## LT - Series

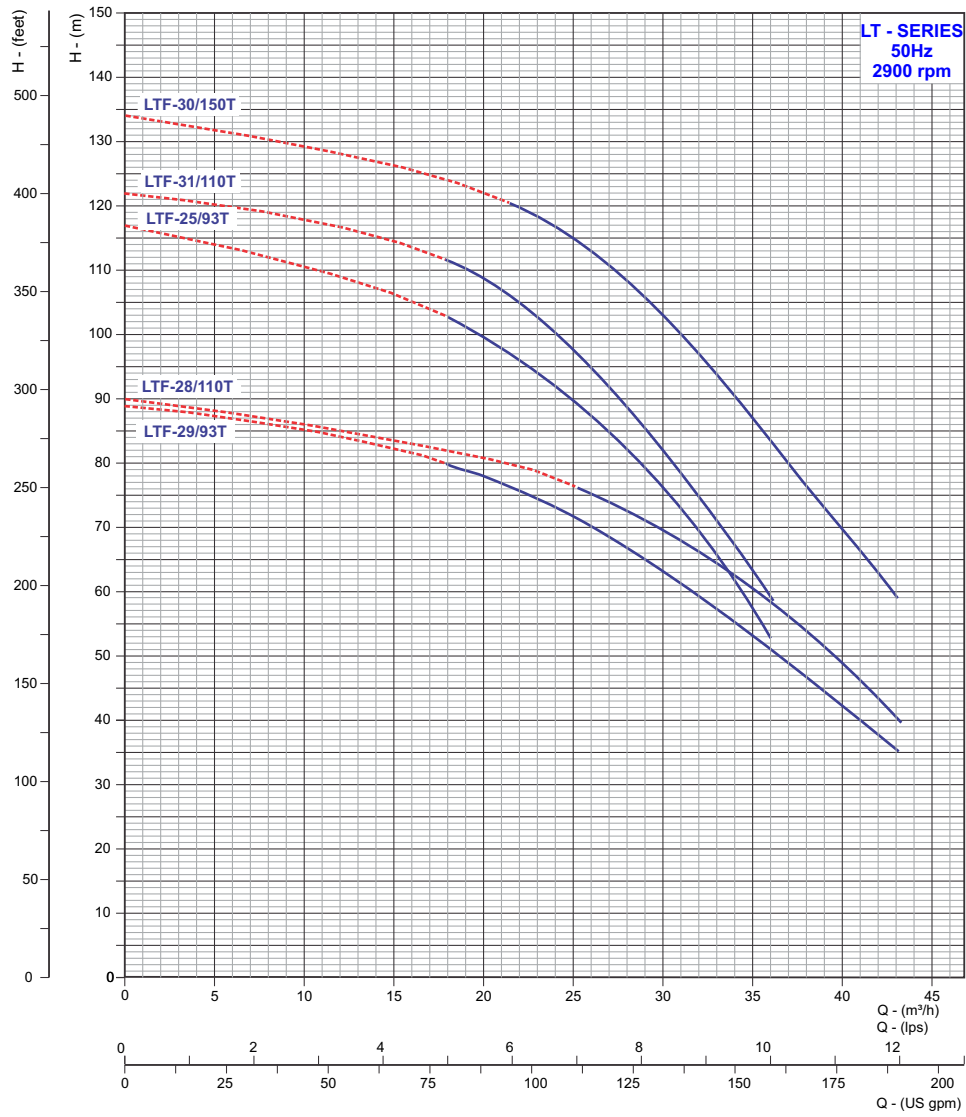

PUMP MODEL	MOTOR POWER		STAGE	OUTLET SIZE IN mm	HEAD IN METERS													
	HP	kW			0	14.4	18	21.6	25.2	28.8	32.4	36	39.6	43.2	46.8	50.4		
LTF-29/93T	12.5	9.3	4	65/80	0	4	5	6	7	8	9	10	11	12	13	14		
LTF-28/110T	15.0	11.0	4	65/80	89		82	76	71	65	58	50	43	36				
LTF-25/93T	12.5	9.3	6	65/80	117		103	97	89	80	68	53						
LTF-31/110T	15.0	11.0	6	65/80	122		111.5	106	98	86	73	59						
LTF-30/150T	20.0	15.0	6	65/80	134			120	115	107	95	83	71	60				

# VERTICAL OPENWELL SUBMERSIBLE PUMPS

## Performance Table & Curves

## LT - Series

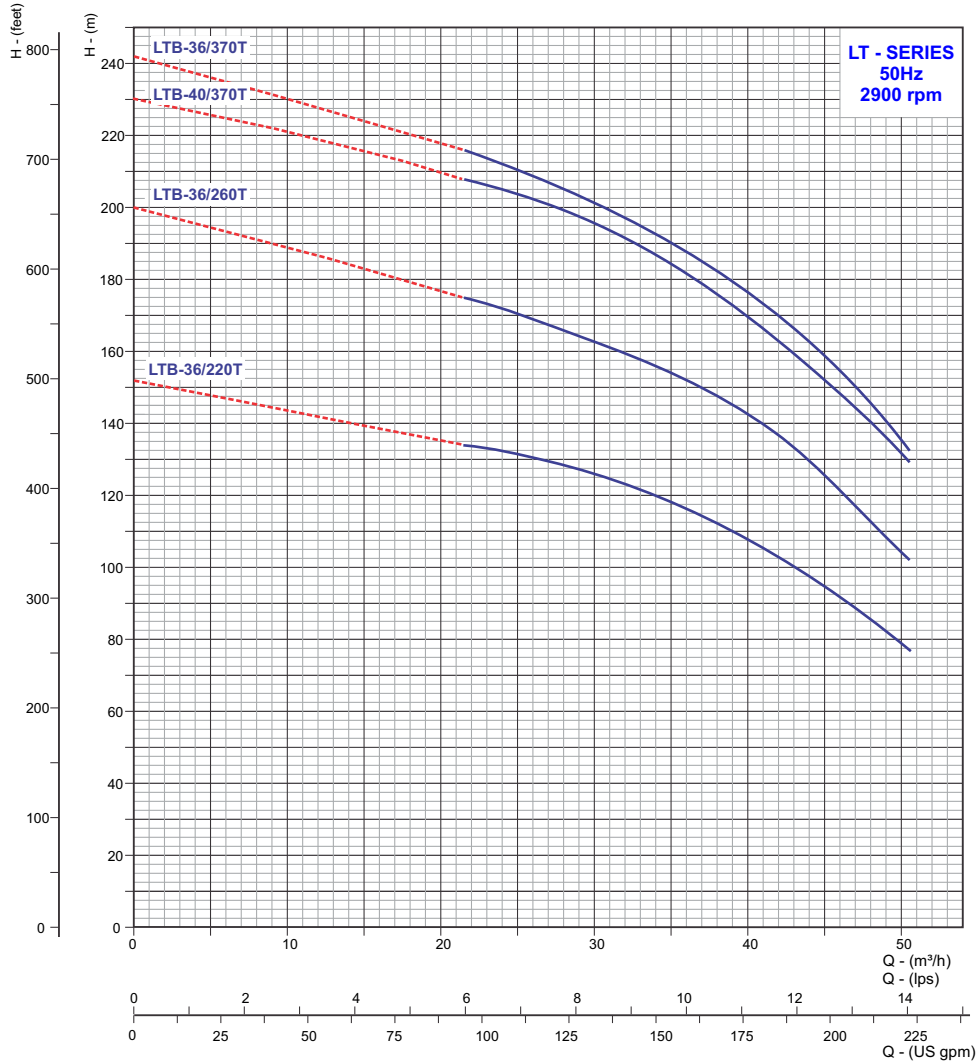

PUMP MODEL	MOTOR POWER		STAGE	OUTLET SIZE IN mm	m³/h	0	14.4	18	21.6	25.2	28.8	32.4	36	39.6	43.2	46.8	50.4	54	57.6
	HP	kW				0	4	5	6	7	8	9	10	11	12	13	14	15	16
LTB-36/220T	30	22	8	80	HEAD IN METERS	152			134	131	127.5	122.5	117.5	109	109	90	78		
LTB-36/260T	35	26	10	80		200			175	170	165	159	152.5	144	144	117.5	103		
LTB-40/370T	50	37	10	80		230			207.5	203	197.5	190	182.5	171.3	171.3	145	130		
LTB-36/370T	50	37	13	80		242			216	211	205	197	187.5	177.5	177.5	150	133		

# VERTICAL OPENWELL SUBMERSIBLE PUMPS

## Performance Table & Curves

## LT - Series

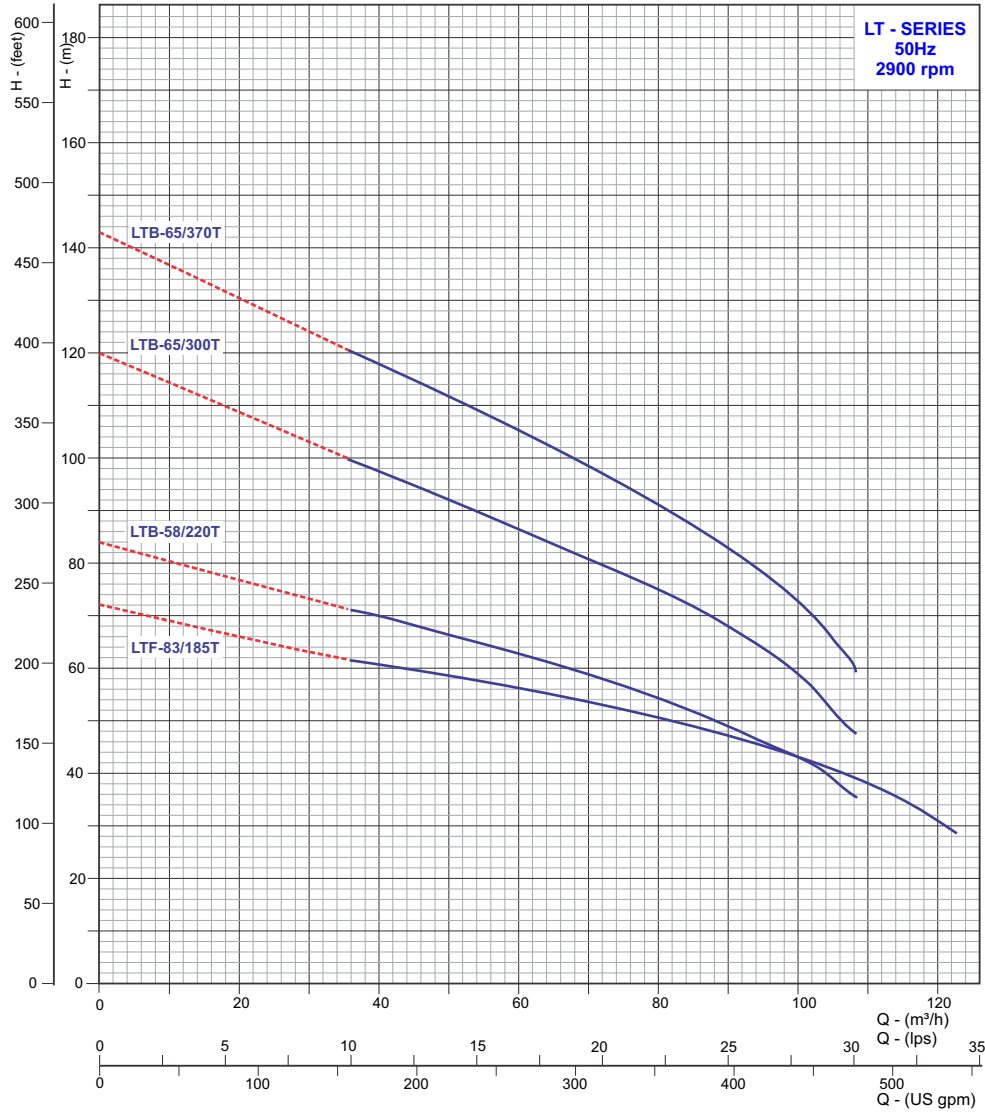

PUMP MODEL	MOTOR POWER		STAGE	OUTLET SIZE IN mm	m³/h	0	75.6	100.8	108	115.2	122.4	129.6	136.8	144	151.2	158.4	165.6	172.8	180
	HP	kW				lps	0	21	28	30	32	34	36	38	40	42	44	46	48
LTF-83/185T	25	18.5	3	100	HEAD IN METERS	72	62	60	58	57	55	53	51	49	47	44	40	35	29
LTB-58/220T	30	22	4	100		84	71	69	66	64	61	58	55	51	47	42	36		
LTB-65/300T	40	30	6	100		120	100	96	92	88	84	80	76	71	65	58	48		
LTB-65/370T	50	37	7	100		143	120	116	111	106	102	98	92	86	80	72	60		

# VERTICAL OPENWELL SUBMERSIBLE PUMPS

Dimension Table

LB & LH - Series

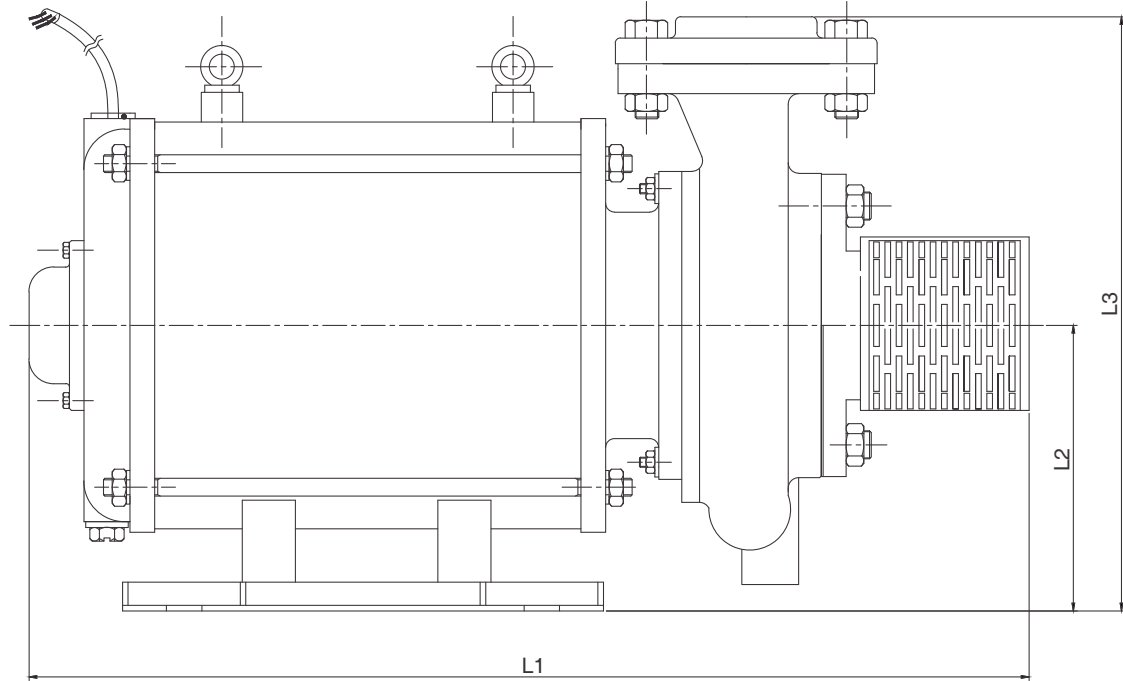

PUMP MODEL	Power kW	OUTLET SIZE	L1	L2	L3
LBB-25/15M	1.5	50	400	262	103
LBB-7/07M	0.75	25	343	228	90
LBB-30/22M	2.2	50	453	283	109
LBB-13E/11M	1.1	25	356	269	106
LBB-16/22M	2.2	40	445	297	123
LBB-11/11M	1.1	25	383	269	110
LHB-31/30T	3	50	630	155	338
LHB-41E/55T	5.5	50	665	155	338
LHB-32/55T	5.5	50	670	150	360
LHB-39/75T	7.5	50	700	180	343
LHF-48/110T	11	50	777	178	453
LHF-39/93T	9.3	50	735	177	417
LHF-54/130T	13	50	812	178	430
LHF-46/110T	11	65	781	178	400
LHB-43/30T	3	65	634	142	367
LHB-65/55T	5.5	65	682	155	367
LHB-55/75T	7.5	65	695	193	390
LHF-66/93T	9.3	65	727	192	433
LHF-83/150T	15	65	825	178	453
LHF-104/185T	18.5	65	899	178	456
LHB-83/40T	4	80	660	155	379
LHB-90/75T	7.5	80	710	178	379
LHF-81/93T	9.3	80	732	178	449
LHF-187/185T	18.5	100	951	167	450
LHF-137/185T	18.5	80	927	167	450

All Dimensions are in mm

# VERTICAL OPENWELL SUBMERSIBLE PUMPS

## Dimension Table

## LT - Series

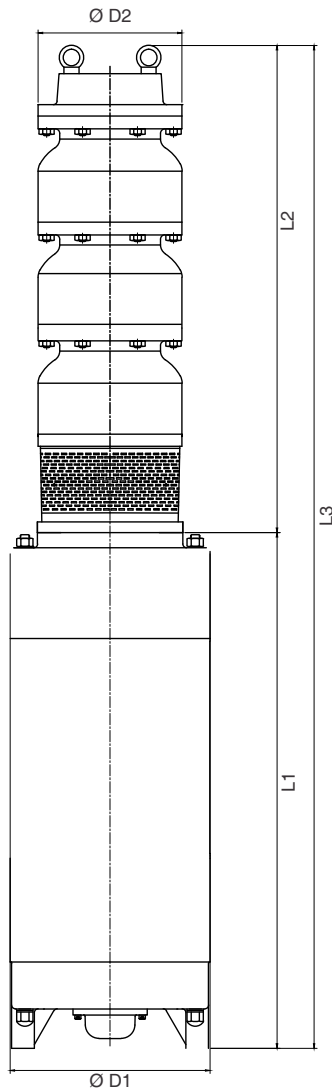

PUMP MODEL	Power kW	OUTLET SIZE	L1	L2	L3	Ø D1 (Motor Dia)	Ø D2 (Pump Dia)
LTG-4/11M	1.1	25/32	315	245	560	184	128
LTG-4/15M	1.5	32/40	344	263	607	184	128
LTG-4/22M	2.2	32/40	374	301	665	184	128
LTF-10/30T	3	50	434	214	648	213	235
LTF-10/37T	3.7	50	434	294	728	213	265
LTF-10/45T	4.5	50	454	334	788	213	265
LTF-10/55T	5.5	50	430	440	870	213	265
LTF-10/75T	7.5	50	520	573	1093	271	265
LTF-10/93T	9.3	50	579	653	1232	271	265
LTF-10/150T	15	50	644	849	1493	271	267
LTF-10/185T	18.5	50	699	849	1548	271	265
LTF-16/45T	4.5	50	454	254	708	213	265
LTF-16/55T	5.5	50	485	294	779	213	265
LTF-16/75T	7.5	50	494	334	828	213	265
LTB-101/260T	26	100	710	500	1310	271	190
LTB-101/300T	30	100	861	520	1381	271	200
LTB-130/450T	45	150	1021	435	1456	275	234.5
LTF-29/30T	3	65	448	213	661	213	267
LTF-27/55T	5.5	65	455	226	681	213	267
LTF-29/75T	7.5	65	490	300	790	213	267
LTF-41E/75T	7.5	65	505	213	718	213	267
LTF-41E/93T	9.3	65	537	225	762	271	267
LTF-40/110T	11	65	572	290	862	271	267
LTF-45/150T	15	65	602	290	892	271	267
LTF-43/185T	18.5	65	629	400	1029	271	305
LTF-36/185T	18.5	65	629	369	998	271	267
LTF-29/93T	9.3	65	450	450	900	271	267
LTF-28/110T	11	65	614	465	1079	271	267
LTF-25/93T	9.3	65	579	593	1172	271	267
LTF-31/110T	11	65	614	593	1207	271	267
LTF-30/150T	15	65	644	592	1236	271	267
LTB-36/220T	22	80	751	720	1471	275	267
LTB-36/260T	26	80	801	849	1650	275	267
LTB-40/370T	37	80	921	849	1650	275	267
LTB-36/370T	37	80	921	1041	1962	275	267
LTF-83/185T	18.5	100	657	384	1041	271	300
LTB-58/220T	22	100	751	599	1350	275	300
LTB-65/300T	30	100	861	789	1650	275	300
LTB-65/370T	37	100	921	884	1805	275	300

All Dimensions are in mm



# W I N N I N G W A Y S

When you have a good thing going it is quite in the fitting of things that recognitions come our way. Several prestigious awards, which decorate our shelf, say it all. These rewards not only acknowledge our position as a leader in the water pump industry but also serve as reminders about what the customer expects from a winner. And we, as ever, have our ears perfectly tuned to customer expectations.



## **C.R.I. VIETNAM - NGOC NGUYEN AN LLC**

**Hotline: 093 824 8589 - Email: info@vnaco.com - Website: www.VinaFluid.com**

## **C.R.I. PUMPS (PVT) LIMITED**

(International Division)

7/46-1, Keeranatham Road, Saravanampatty, Coimbatore - 641 035. India.

Phone : +91-422-3911610, 3911612. Fax : +91-422-3911600 e-mail : cri@criexports.com website: www.crigroups.com

## **C.R.I. BOMBAS HIDRÁULICAS LTDA**

Av. Rodrigo Fernando Grillo, 457, Jd. Manacas,  
CEP - 14.801-534, Araraquara - SP, Brasil.

Fone : +55-16-3331 1099, Fax +55-16-3331 5344

e-mail : cri@cribombas.com.br website : www.cribombas.com.br

Filial : Jabotão dos Guararapes-PE, Brasil.

Fone : (81) 3093-9620, Fax : (81) 3093-9600.

## **C.R.I. PUMPS (Shanghai) Co., Ltd.**

Building 53 (No. 17), 588 Yindu Road,  
Minhang District, Shanghai, China.

Tel : 021-54405082, Fax : 021-54405083

e-mail : cri@bombascri.com.cn website : www.bombascri.com.cn

## **C.R.I. PUMPS S.A. (PTY) LIMITED**

P.O. Box 6292, Halfway House, Midrand - 1685,  
Johannesburg, South Africa.

Tel : +27-11-8058631 / 32 Fax : +27-11-8058630

e-mail : cri@cripumps.co.za website : www.cripumps.co.za

Branch : Capetown : + 27-21-931 2516

## **BOMBAS C.R.I. ESPAÑA,S.L.**

Poligono Industrail El.Bony Calle 31, No.137, 46470

Catarroja (Valencia) Spain.

Tel: +34-96 1842 974 Fax: +34-96 1842 977.

Email: cri@bombascri.es Website: www.bombascri.es

## **C.R.I. POMPA SANAYİ VE TİCARET LİMİTED ŞİRKETİ**

10032 Sk. No:12 A.O.S.B. 35620 Çiğli-İzmir-Türkiye.

Tel : +90-232-328 22 99 Fax : +90-232-328 23 33

E-mail: cri@cripompa.com Website: www.cripompa.com

## **C.R.I. PUMPS (FZE)**

P.O. Box 7988, A4-40 SAIF-Zone, Sharjah, U.A.E.

Tel : +971-6-5573041 (3 Lines), Fax : +971-6-5573042

e-mail : cripumps@eim.ae website : www.cripumps.com